



PRE-WALL INSTALLATION SYSTEMS

2020



THAT MAGICAL FEELING
WHEN YOU COME HOME AND
EVERYTHING LOOKS SO GOOD

WE LIVE
IN TIME
OF THINNING .



**Thinness is a dimensionality
that defines in our interiors and
generally in design the level
of beauty and functionality.**

Alcaplast is a company that creates trends. We realize that every millimeter we can reduce our modules, flush plates and other products is important. So we bring a number of innovations in line with this idea.

And you can be surrounded by more subtle and more sophisticated beauty.

CONTENT.

6-9

Flush plates THIN

The clean lines and precision manufacture contribute to make flush plates THIN almost invisible by merging with the tiles in your bathroom.



20-33

Pre-wall installation systems ALCA

Pre-wall installation systems ALCA are manufactured using the latest technology and top grade materials. Thus they have been tested and proven for long-term durability and functionality.



10-15

Flush plates FLAT

Elegance and beauty – these are the fine characteristics of our flush plates FLAT. They were designed with the most demanding customers in mind.



24-27

Saving water and fresh air

Efficient and discreet. Pre-wall installation systems ALCA think about your needs. While ECOLOGY guarantees the reduction of water consumption, powerful extraction fan ensures your personal comfort.



28-31

Adaptable solutions

Little space? The bathroom in the attic? No problem. We have solution for all types of brick houses and also wooden constructions.

**TOGETHER
WE CREATE A PLACE
WHERE YOU CAN
RE-ENERGIZE**



Lets make it simple

We have prepared a QR code for each product for your convenience. To read the QR codes just download the application to your smart phone or tablet. Then scan the code to quickly reach the desired section of our website. Here you will find detailed descriptions and parameters of the selected product. No more trouble with searching for information. A smart way to get your information quickly and easily.

Flush plates THIN	6-9
Flush plates FLAT	10-15
NIGHT LIGHT.....	12-13
FLAT ALUNOX.....	14
Flush plates ALCA	17-18
Pre-wall installation systems ALCA	20-33
ECOLOGY.....	24-25
With ventilation.....	26-27
With top or front actuation.....	28-29
Wood.....	30-31
Medic Assistant.....	32-33
Overview of pre-wall installation systems ALCA	34-35
Mounting frames ALCA for plumbing fixtures	36
For wash-basins and faucets.....	36
For bidets, urinals and others.....	36
Sensor program	37
Specification of ALCA pre-wall installation systems	38-39
Company Alcplast	40-41



Flush plates

FLUSH PLATES THIN

THIN ELEGANCE.

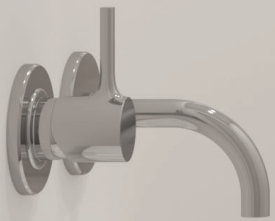

AM1101/1200
+ flush plate M576

Pre-wall installation
system for dry build up
with plastic flush plate

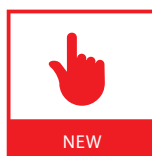

M576
White-matt
External dimensions:
247 × 165 × 5 mm

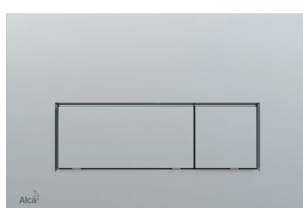

M572
Chrome-matt
External dimensions:
247 × 165 × 5 mm



M775
White/gold
External dimensions:
247 × 165 × 5 mm



**SLIM
module**

BORDER BETWEEN BEAUTY AND ELEGANCE IS THIN



Refined style

The flush plate is the only visual element of the sophisticated installation system, which you can see on the toilet. Therefore it deserves your attention. We emphasize the timeless design, which determines the appearance of the toilet. The perfect operation and easy installation is a matter of course. A complete menu of flush plates on pages 17 to 18.



Fully compatible with all ALCA WC modules

The flush plates can be freely combined with all ALCA pre-wall installation systems thanks to 100% compatibility.



Only 5 mm

Introducing the new flush plates labeled THIN, which thanks to its flat profile stands out only five millimeters above the tiles. Guaranteeing a perfect and discreet merge with the rest of your toilet or bathroom. In combination with pre-wall installation systems SLIM it saves extra centimeters in the toilet space.

6 colour variants

Series of flush plates THIN are available in six colour variants, from the traditional white through the favourite chrome, extravagant gold, to black finish, in both square and round designs ensure that you can achieve clean lines, precise finish and silent operation.





Flush plates

FLUSH PLATES THIN

SMOOTH AS SATIN.



**AM1115/1000
+ flush plate M676**

Pre-wall installation system for building into solid walls with flush plate white-matt



M776

White-matt/chrome-polished
External dimensions:
247 × 165 × 5 mm

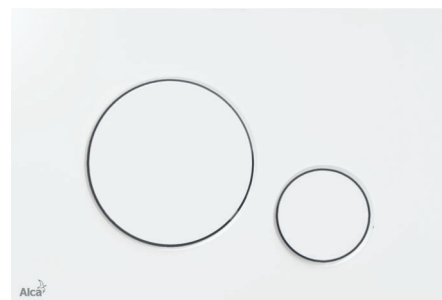

M676

White-matt
External dimensions:
247 × 165 × 5 mm



M576

White-matt
External dimensions:
247 × 165 × 5 mm



WHITE-MATT DOES NOT INTRUDE IT ONLY DECORATES



Pleasing to see and touch

Whilst creating the new white flush plates we were inspired by delicacy of satin materials. We developed the product to be pleasant visually and to the touch. New flush plates THIN were designed and manufactured with the emphasis on the perfect choice of materials, precise craftsmanship and ideal colour design.



Fully compatible with all ALCA WC modules

Thanks to 100% compatibility the new flush plates can be combined with all ALCA pre-wall installation systems.



Anti-fingerprint

The surface of the flush plates have a special protective layer, which does not show smears or finger marks. Due to this protective layer, the flush plates do not require frequent maintenance or cleaning thus greatly extending their lifetime.



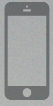

• Flush plates

FLUSH PLATES FLAT

HARMONY OF MATERIALS.



AM100/1000 + flush plate FUN-BRASS

Pre-wall installation system for building into solid walls with flush plate FUN-BRASS



STING

Alunox-matt/polished
External dimensions: 247 x 165 x 26 mm

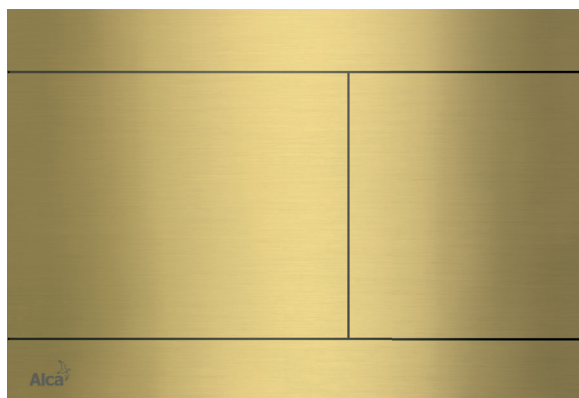

FUN-BRASS

Brass
External dimensions: 247 x 165 x 5 mm



**FLUSH PLATES
FLAT SERIES.
TIMELESS LOOK,
PREMIUM
MATERIALS
AND FLAWLESS
OPERATION.**



**New brass flush plate
FUN-BRASS**

Metal flush plate FUN-BRASS with brass finish has a thickness of only 5 mm so it barely rises over the tile. Elegant design and attractive colours can be effectively used in the concept of a modern toilet. Also this flush plate has a special Anti-fingerprint protection.



Simply compatible

We believe that perfect things do not have to be complicated. That's why we developed our flush plates so that they can be combined with all pre-wall installation systems ALCA. Therefore you can select any flush plate that you like in style and you are not limited. In addition, the installation is very easy and quick. The new flush plates are fully interchangeable with existing installations and change over is quick and easy.

Glass flush plates STRIPE

Glass flush plates in white or black colour fit any modern bathroom thanks to the fine design. Emphasis on details and a simple shape makes exclusive glass material and stainless steel elements stand out.





Flush plates

FLUSH PLATES FLAT

THE FUTURE AT YOUR FINGERTIPS. ■

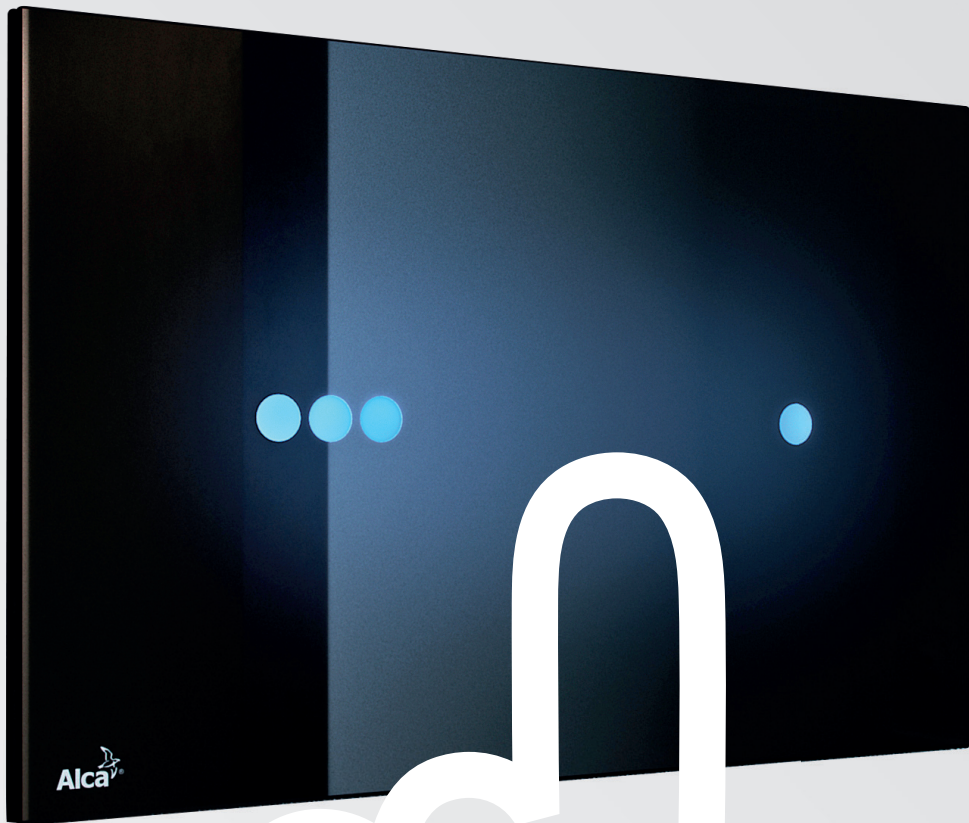



INNOVATIVE TOUCH-FREE FLUSH PLATES NIGHT LIGHT



Ultimate flexibility

Illuminated flush plates Night Light excel in a number of adjustable parameters. Choose the colour according to your current mood and set other functions of the flush plate as you like it.



Barbra Škorpilová

Architect, designer and the creator of the flush plates FLAT ALUNOX, NIGHT LIGHT and M370–M475 for ALCAPLAST, Barbra is today known for her association with the MIMOLIMIT studio which she founded in 2001.



**NIGHT LIGHT-1
NIGHT LIGHT-1-SLIM**

Glass-black
External dimensions:
247 × 165 × 7 mm



**NIGHT LIGHT-2
NIGHT LIGHT-2-SLIM**

Glass-black
External dimensions:
247 × 165 × 7 mm

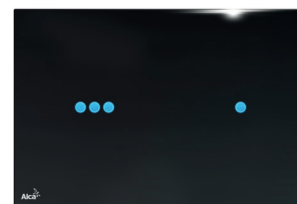

**NIGHT LIGHT-3
NIGHT LIGHT-3-SLIM**

Glass-black
External dimensions:
247 × 165 × 7 mm



Innovative touch-free flush plate NIGHT LIGHT

It works without direct contact for even greater comfort.

The interconnection of design and functionality won the prestigious IF Design Award 2018.





Flush plates

FLUSH PLATES FLAT

WORLD DESIGN. ■



reddot award 2014
winner

FUN
Alunox-matt
External dimensions:
247 x 165 x 5 mm



STING
Alunox-matt/polished



TURN
Alunox-matt/polished



STRIPE
Alunox-matt/polished



AIR
Alunox-matt

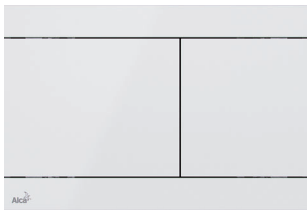

FUN-WHITE
Inox-white polished

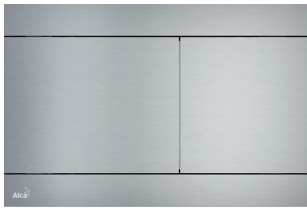

FUN
Alunox-matt



FUN-INOX
Inox-semi matt

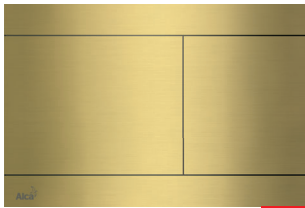

FUN-BRASS
Brass



FUN-ANTIC
Bronze-antic



FLAT FUN FOR EVERY INTERIOR



Anti-fingerprint

The surface of the FLAT flush plates have a special protective layer, which does not show smears or finger marks. Due to this protective layer, the flush plates do not require frequent maintenance or cleaning thus greatly extending their lifetime.



Illuminated FLAT ALUNOX flush plate

Introducing the flush plate AIR LIGHT, which in combination with backlighting brings a pleasant subdued lighting that highlights the functional and design solutions of your bathroom.

Available in following colours: blue, red, green, white and rainbow







Flush plates

THIN (THICKNESS 5 MM)



M770 White/chrome-polished



M771 Chrome-polished/
chrome-matt



M772 Chrome-matt/
chrome-polished



M778 Black-matt/
chrome-polished



M775 White/gold

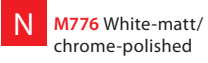

N M776 White-matt/
chrome-polished

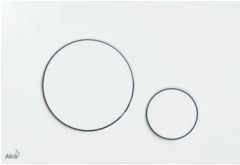

M670 White



M671 Chrome-polished

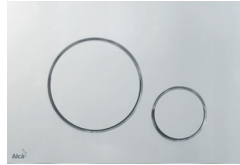

M672 Chrom-mat



M678 Black-matt

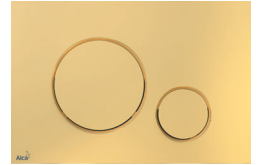

M675 Gold



N M676 White-matt



M570 White

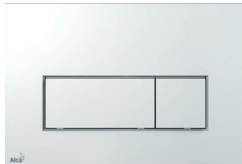

M571 Chrome-polished

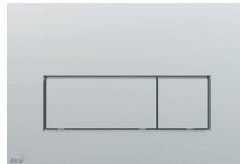

M572 Chrome-matt



M578 Black-matt



M575 Gold



N M576 White-matt

BASIC



M70 White



M71 Chrome-polished



M72 Chrome-matt



M73 Chrome-polished/matt



M75 Gold



M270 White



M271 Chrome-polished



M272 Chrome-matt



M278 Black-matt



M275 Gold

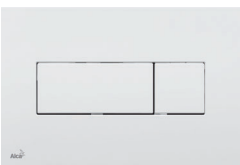

M370 White

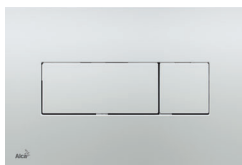

M371 Chrome-polished

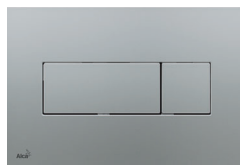

M372 Chrome-matt



M378 Black

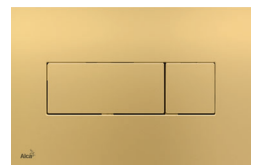

M375 Gold

BASIC



M1710 White



M1710-8 White/black

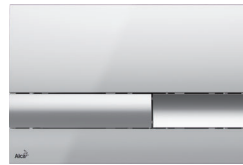

M1741 Chrome-polished



M1718 Black

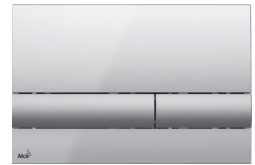

M1713 Chrome-polished/
matt



M1720-1 White/chrome-
polished

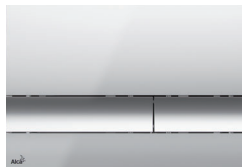

M1721 Chrome-polished

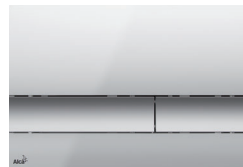

M1722 Chrome-matt



M1728-2 Black/chrome-matt

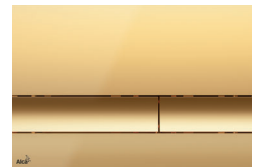

M1725 Gold

FLAT ALUNOX (ALUMINUM) / FLAT INOX (STAINLESS STEEL)



TURN Alunox-matt/polished

TURN-INOX Inox-semi matt/
polished



STING Alunox-matt/polished

STING-INOX Inox-semi matt/
polished



FUN Alunox-matt

FUN-INOX Inox-semi matt



STRIPE Alunox-matt/polished

STRIPE-INOX Inox-semi matt/
polished



AIR Alunox-matt

AIR-INOX Inox-semi matt

FLAT COLOUR (COLOUR HIGH GLOSS)

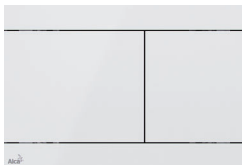

FUN-WHITE Inox-white
polished



STRIPE-WHITE Inox-white
polished



STRIPE-BLACK Inox-black
polished



STRIPE-GL1200 Glass-white



STRIPE-GL1204 Glass-black

FLAT



FUN-BRASS Brass



FUN-ANTIC Bronze-antic



AIR LIGHT Alunox-matt

AIR LIGHT (ALUMINUM WITH ILLUMINATION)

TOUCH-FREE (GLASS)



NIGHT LIGHT-1
Glass-black

NIGHT LIGHT-1-SLIM
Glass-black

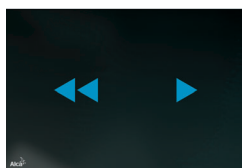

NIGHT LIGHT-2
Glass-black

NIGHT LIGHT-2-SLIM
Glass-black

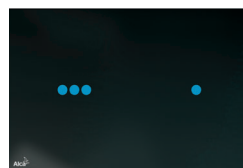

NIGHT LIGHT-3
Glass-black

NIGHT LIGHT-3-SLIM
Glass-black

CHOOSE
THE PERFECT
FINAL PIECE
OF THE MOSAIC.



↓
AM100/850 + flush plate M672
Pre-wall installation system for building into solid walls
with plastic flush plate

15
YEAR GUARANTEE



Pre-wall installation systems

PRE-WALL INSTALLATION SYSTEMS

CZECH ENGINEERING.

15
YEAR GUARANTEE



AM1115/1000 + flush plate M1728-2

Pre-wall installation system for building into solid walls with plastic flush plate



WE TRUST OUR PRODUCTS THUS WE PROVIDE AN EXTENDED 15 YEAR WARRANTY



Complete range

The range of pre-wall installation systems ALCA is designed to be able to cover all possible uses. This includes not only building into solid walls, dry build up into plasterboard but also an option to install the system into open bathroom spaces.

Simply compatible

All our flush plates can be freely combined with all pre-wall installation systems ALCA. Installation is very easy and quick. It is easy to exchange old flush plates with new ones on already installed system.



Basic / Standard systems

Thanks to many years of experience in the market of pre-wall installation systems our WC modules can deal with any space.

Systems ECOLOGY

Water is becoming a rare commodity and will soon become one of the most valuable sources in the world. Alcaplast company offers efficient WC systems series ECOLOGY, which can save 33% of water with every flush. This saves not only our planet but also your expenses. They are marked with the letter "E" in the product code.



Systems with ventilation

In the event of insufficient natural ventilation of the toilet area, we offer solutions with forced air ventilation through the toilet bowl. These models of pre-wall installation systems ALCA are marked "V" in their code.

Systems with top or front actuation

A flexible solution that allows you to place the flush plate on the cistern in the horizontal position. It is used mainly in attic apartments or if the toilet is located under the window sill.



Systems WOOD for wooden construction houses

Special solution for wooden construction houses or mobile residential units has an outstanding protection against possible water leakage into the wooden structure of the house. The new construction allows tilting the cistern forward. The pre-wall installation system can be easily mounted to the wooden construction through the holes in the frame.

Systems SLIM

In small spaces, concrete panel housing units, plasterboard partitions or reconstructions. Slim systems have a thickness only 84 mm, so you can save space and easily realise even a small bathroom or toilet.



PRE-WALL INSTALLATION SYSTEMS

EASY INSTALLATION.



New Feet Locking system

There is a new system for the "frame feet" that allows you to easily set the necessary building height and then tighten to ensure its final position. This eliminates the need for the assistance of another person during installation and also increases the accuracy of the installation.



Sliding rail holder of waste connector

The new way of fixing the waste connector makes the installation much easier. The waste connector can be now moved horizontally and its depth can be modified with respect to the frame in eight positions up to 93 mm. It's much easier to mount different types of toilet bowls that would otherwise require more complex interventions when they are installed.



Water supply pipe with o-ring

The bayonet system allows the installation of the flexible hose and the fill valve without tools. Everything should be tightened by hand only.



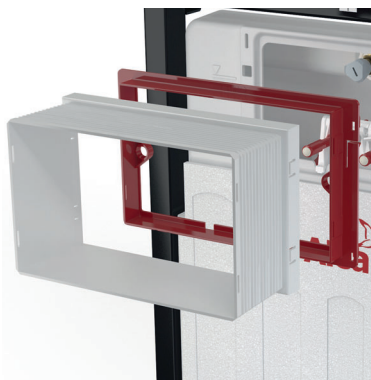

Installation frame and sleeve

The fastening of the sleeve frame to the reservoir has been changed. Now, installation is accomplished by simply snapping it on, thus greatly speeding up the installation time. This frame can also be used when installing into plasterboard.



Template for correct flush plate setup

The new template will greatly assist in setting the flush mechanism to achieve perfect function. It is included in the flush plate packaging.



Service through the flush plate opening

Routine maintenance and adjustment of the water volume of small and large flushes can be easily resolved through the sleeve of the flush plate. With guaranteed availability of spare parts 25 years you need not to worry.

Installation and service video

Enter in your web browser address www.alcaplast.com/instalace or scan the QR code using a smartphone.



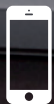

Pre-wall installation systems

PRE-WALL INSTALLATION SYSTEMS ECOLOGY

SAVING
WATER.

15

YEAR GUARANTEE



**Variants of pre-wall
installation systems
ECOLOGY**

AM100/1000E Alcamodul
AM115/1000E Renovmodul
AM101/1120E Sádromodul
AM102/1120E Jádromodul

see p. 34

↓
AM101/1120E + TURN

Pre-wall installation system ECOLOGY for
dry build up (plasterboard) with flush plate
alunox-matt/polished



SAVING 33 % OF WATER AT EACH FLUSH



Innovative product in the field of sustainable development

Pre-wall installation system ECOLOGY that uses a small volume of water for flushing the toilet bowl, won the prestigious Gaia Awards 2014 exhibition THE BIG 5 in Dubai.



Systems Ecology

Pre-wall installation systems ECOLOGY contain the flush valve which allows flushing with a smaller water volume than those for standard systems. The dual volume technology for flushing 2/4 l meets the latest environmental and economical requirements, at the same time saves 33 % of water with every flush.



Change your built in WC system to ECOLOGY

Any pre-wall installation system ALCA (except Slim system) can be easily converted to an ECOLOGY variant by exchanging for the flush valve A06E and choosing the correct type of the WC bowl. The flushing volume can be continuously adjusted from 2 to 9 l. At the same time it can be, if necessary, returned to the standard flushing volume 3/6 l.



Conserve nature and save your money

Pre-wall installation system has to meet the requirements defined by EU standards. The volume of flushing water for the standard systems is usually 3/6 l. The trend is to reduce the production of waste water by reducing the consumption of water intended for flushing, thereby reducing the environmental impact. The lower water consumption also saves your money.



Pre-wall installation systems

PRE-WALL INSTALLATION SYSTEMS
WITH VENTILATION

ALWAYS
FRESH AIR. ■

15
YEAR GUARANTEE



↓
AM101/1120V
+ flush plate FUN + P128
Pre-wall installation system
with ventilation for dry build up with
flush plate alunox-mat
and extraction fan

**Variants of pre-wall
installation systems
with ventilation**

AM115/1000V Renovmodul
AM101/1120V Sádromodul
AM102/1120V Jádromodul

see p. 34



EFFECTIVE AND QUIET VENTILATION WITH IMMEDIATE ELIMINATION OF UNWANTED ODOURS



Modules with ventilation

Our range of pre-installation system with ventilation remove odour directly from the toilet bowl. The powerful extraction fan immediately vents the odour from the room.



System solution

The system features powered ventilation to extract odour directly from the toilet bowl. These are models of pre-wall installation systems ALCA marked "V" and the extraction fan.

It is particularly suitable for toilets without windows, or as ventilation for toilets placed in bathrooms. Thus ensuring effective ventilation of the bathroom and reducing the moisture and odours when using the toilet.



For all types of WC modules

The variant with ventilation is offered for all types of pre-wall installation systems.

Sádromodul AM101/1200V,
Jádromodul AM102/1200V
are designed for dry build up into the plasterboard.

Renovmodul AM115/1000V
is designed for building into solid walls during the renovations.



No additional costs

The extraction fan, which is connected to WC modules with ventilation, is a one-time expense. When choosing this method of extraction the customer does not have to think about any other expenses, such as charcoal filters.



Pre-wall installation systems

PRE-WALL INSTALLATION SYSTEMS
WITH TOP OR FRONT ACTUATION

FLEXIBLE SOLUTION.

15
YEAR GUARANTEE



AM118/850
+ flush plate FUN-WHITE

Pre-installation system
with top or front actuation
with flush plate
Inox-white polished

**Variants of pre-wall
installation systems
with top or front
actuation**

AM119/1000 Renovmodul
AM119/850 Renovmodul
AM118/1000 Sádromodul
AM118/850 Sádromodul

see p. 35



UNIVERSAL SYSTEM FOR NON-STANDARD SPACES



Systems with top or front actuation

You need to place the toilet in an attic with a sloping roof or the window sill hinders you? Pre-wall installation system with top or front actuation is a solution for such a situation. The flush plate is simply placed in the horizontal position.

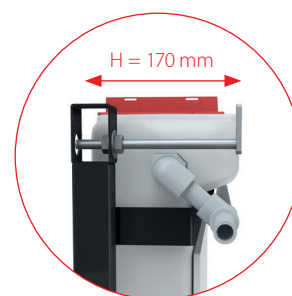

Opportunity to choose

Top actuation elegantly solves the problem of WC modules with low build height where the open WC seat cover can overlap the flush plate. WC modules AM118 and AM119 are available in two construction heights of 850 or 1000{1}mm. We offer the module AM119 for building into solid walls and also for dry build up. For dry build up AM118



100% Compatibility of flush plates

Modules with the top or front actuation are fully compatible with all flush plates Alca. The dual flush action means that you can choose the volume of flush water, large or small, according to your needs, including the option ECOLOGY for water-saving flushing 2/4 liters. When the flush plate is placed in the horizontal position it accentuates the profile of models FLAT or THIN.



Space saving solution

Thanks to side water connection and a new shape of WC cistern our construction engineers have achieved a minimum installation depth of 170 mm for pre-wall installation systems with top actuation. Without any additional construction work to connect to water supply line.



Pre-wall installation systems

PRE-WALL INSTALLATION SYSTEMS
FOR WOODEN-CONSTRUCTION HOUSES

HARMONY WITH NATURE.

15
YEAR GUARANTEE

NEW



AM101/1120W + M570

Pre-wall installation system for dry build up
(plasterboard) with white flush plate

Variants of pre- installation systems for wooden construction houses

AM112W Basicmodul
AM101/1120W Sádromodul
AM101/850W Sádromodul

see p. 35

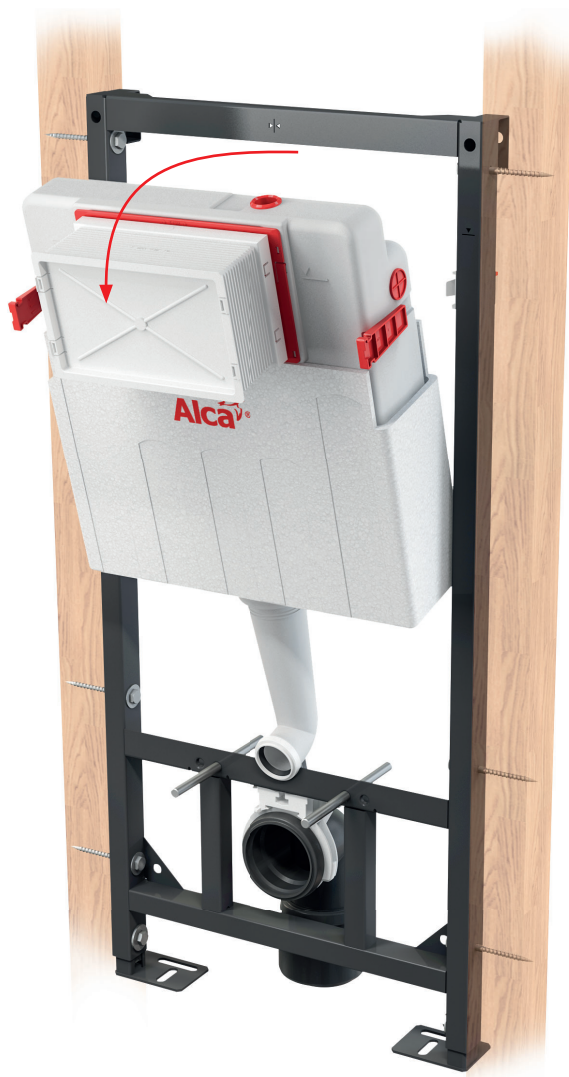

SPECIFICALLY DEVELOPED FOR WOODEN CONSTRUCTION HOUSES



Safe water connection

Connection of water to angle valve inside of the cistern guarantees increased protection against possible leakage of water into the wooden construction of the house.

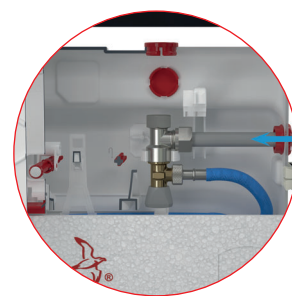

Easy mounting to wooden construction houses

The new construction solution allows tilting the cistern forward. The pre-wall installation system can be easily attached to the wooden construction through the holes in the frame.





Pre-wall installation systems

PRE-WALL INSTALLATION SYSTEM HEIGHT ADJUSTABLE
FOR PEOPLE WITH REDUCED MOBILITY

NO BARRIERS

15
YEAR GUARANTEE



↓
**AM101/1500L Medic Assistant
+ WC Alca MEDIC**

Pre-wall installation system for dry
build up, height adjustable – for people
with reduced mobility

**Variants of pre-
installation systems
for people with
reduced mobility**

AM116/1300H Solomodul
AM101/1300H Sádromodul
AM101/1500L Medic Assistant

see p. 35

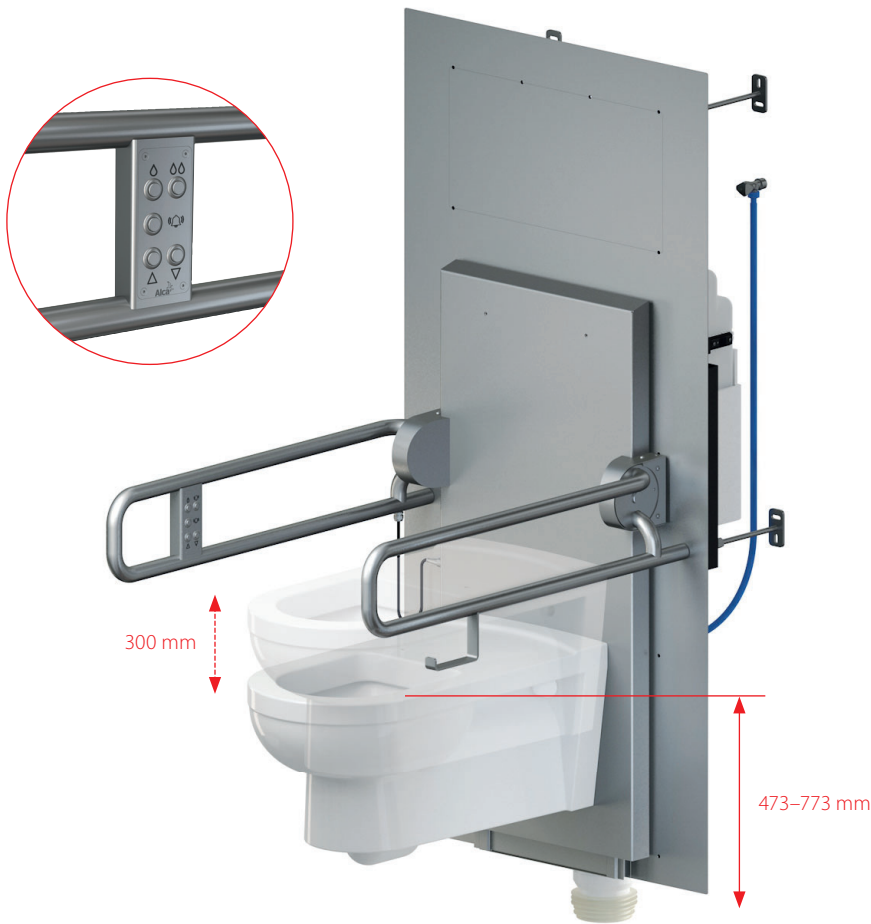

SPECIAL BARRIER-FREE SOLUTION IMPROVES QUALITY OF LIFE



Safe solution for the future

We may face various periods in life when we must rely on the help of others, whether by accident, surgery or old age. Medic Assistant enables the smooth height adjustment of the toilet bowl in the range of 30 cm for maximum independence and comfort in the bathroom. Comfortable dual water-saving flushing is integrated directly in the support handle, which includes also an alert system button for immediate call for help.



Comprehensive barrier-free program

Barrier-free program includes a range of various products (pre-wall installation systems for people with reduced mobility, mounting frames for handles, barrier-free shower drains, etc.).

More on

 www.alcaplast.com/en/barrier-free-program



PRE-WALL INSTALLATION SYSTEMS ALCA

Basic



AM112 Basicmodul
Wall concealed WC cistern



AM100/1000 Alcamodul
Pre-wall installation system for building into solid walls



AM100/850 Alcamodul
Pre-wall installation system for building into solid walls



AM115/1000 Renovmodul
Pre-wall installation system for building into solid walls



AM101/1120 Sádromodul
Pre-wall installation system for dry build up (plasterboard)



AM101/1000 Sádromodul
Pre-wall installation system for dry build up (plasterboard)



AM101/850 Sádromodul
Pre-wall installation system for dry build up (plasterboard)



AM102/1120 Jádromodul
Pre-wall installation system for dry build up (especially for renovation of concrete panel housing units)



AM102/1000 Jádromodul
Pre-wall installation system for dry build up (especially for renovation of concrete panel housing units)



AM102/850 Jádromodul
Pre-wall installation system for dry build up (especially for renovation of concrete panel housing units)

ECOLOGY



AM100/1000E Alcamodul
Pre-wall installation system ECOLOGY for building into solid walls



AM115/1000E Renovmodul
Pre-wall installation system ECOLOGY for building into solid walls



AM101/1120E Sádromodul
Pre-wall installation system ECOLOGY for dry build up (plasterboard)



AM102/1120E Jádromodul
Pre-wall installation system ECOLOGY for dry build up (especially for renovation of concrete panel housing units)

With ventilation



AM115/1000V Renovmodul
Pre-wall installation system with ventilation for building into solid walls



AM101/1120V Sádromodul
Pre-wall installation system with ventilation for dry build up (plasterboard)



AM102/1120V Jádromodul
Pre-wall installation system with ventilation for dry build up (especially for renovation of concrete panel housing units)



P128
Extraction fan for pre-wall installation systems with ventilation

Properties of ALCA pre-wall installation systems

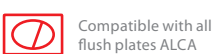

Compatible with all flush plates ALCA



Warranty 15 years

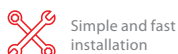

Simple and fast installation



Load capacity 400 kg

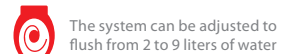

The system can be adjusted to flush from 2 to 9 liters of water

H = Installation depth



Visit us on the Web



With top actuation



AM119/1000 Renovmodul
Pre-wall installation system for building into solid walls with top or front actuation



AM119/850 Renovmodul
Pre-wall installation system for building into solid walls with top or front actuation



AM118/1000 Sádromodul
Pre-wall installation system for dry build up (plasterboard) with top or front actuation



AM118/850 Sádromodul
Pre-wall installation system for dry build up (plasterboard) with top or front actuation

For wooden construction houses



AM112W Basicmodul
Wall concealed WC cistern



AM101/1120W Sádromodul
Pre-wall installation system for dry build up (plasterboard)



AM101/850W Sádromodul
Pre-wall installation system for dry build up (plasterboard)

SLIM



AM1112 Basicmodul Slim
Wall concealed WC cistern



AM1115/1000 Renovmodul Slim
Pre-wall installation system for building into solid walls



AM1101/1200 Sádromodul Slim
Pre-wall installation system for dry build up (plasterboard)

Self-supporting



AM116/1120 Solomodul
Pre-wall installation system for dry build up (self-supporting)

For people with reduced mobility



AM116/1300H Solomodul
Pre-wall installation system for dry build up (self-supporting) – for people with reduced mobility



AM101/1300H Sádromodul
Pre-wall installation system for dry build up (plasterboard) – for people with reduced mobility



A106/1120
Mounting frame for handle

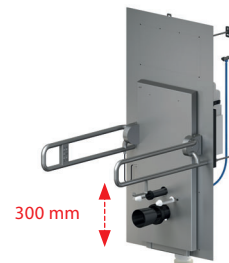

AM101/1500L Medic Assistant
Pre-wall installation system for dry build up, height adjustable – for people with reduced mobility

Attributes of the program for people with reduced mobility



Reinforced construction



Possibility of supporting handles installation



Barrier-free solutions



Comfortable accessibility of flushing

H = Installation depth

MOUNTING FRAMES

For wash-basins and faucets



A104/1120
Mounting frame
for wash-basin



A104/1000
Mounting frame
for wash-basin



A104/850
Mounting frame
for wash-basin



A117B
Mounting frame for
faucet to the plasterboard
structure



A104A/1120
Mounting frame
for wash-basin
and faucet



A104AVS/1120
Mounting frame for wash-
basin and faucet with
built-in trap



A104B/1120
Mounting frame
for faucet



A104PB/1120
Mounting frame
for built-in mixer



A117PB
Mounting frame
for built-in mixers in
plasterboard structure

For bidets, urinals and others



A105/1120
Mounting frame
for bidet



A105/1000
Mounting frame
for bidet



A105/850
Mounting frame
for bidet



A105/450
Mounting frame
for bidet



A107/1120
Mounting frame
for urinal



A107S/1200
Mounting frame for a urinal
and sensor



A106/1120
Mounting frame
for handle



A108/1300
Mounting frame for waste
sink and faucet



A108F/1100
Mounting frame with
cistern for a waste sink
with outlet connection
DN90/110 and faucet



A108F/1500
Mounting frame with
cistern for a waste sink
with outlet connection
DN90/110 and faucet



A113/1120
Mounting frame for
wall-hung WC combi



A114/1120
Mounting frame
for wall-hung WC



A114S/1200
Mounting frame for
wall-hung WC
and sensor

Mounting frames attributes



Warranty
15 years

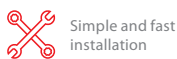

Simple and fast
installation



Load capacity
400 kg

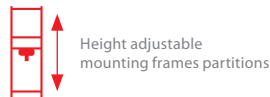

Height adjustable
mounting frames
partitions

SENSOR PROGRAM

Flush plates with sensor



M279S Antivandal
M279S-SLIM Antivandal

Flush plate Antivandal with sensor for pre-wall installation systems, metal (AC power supply)

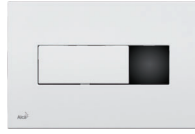

M370S
M370S-SLIM

Flush plate with sensor for pre-wall installation systems, white (AC power supply)

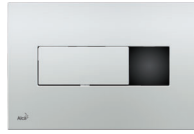

M371S
M371S-SLIM

Flush plate with sensor for pre-wall installation systems, chrome-polished (AC power supply)

M279SB Antivandal
Flush plate Antivandal with sensor for pre-wall installation systems, metal (DC battery operated)

M370SB
Flush plate with sensor for pre-wall installation systems, white (DC battery operated)

M371SB
Flush plate with sensor for pre-wall installation systems, chrome-polished (DC battery operated)

Remote flushing



MPO10

Remote pneumatic flush for hand operation, white, installation: into the wall



MPO11

Remote pneumatic flush for hand operation, chrome-polished, installation: into the wall



MPO12

Remote pneumatic flush for foot operation, metal, installation: onto the floor



MPO13

Remote pneumatic flush for foot operation, metal, installation: onto the wall

Automatic WC flushing systems



ASP3

Automatic WC flushing system, chrome, 12 V (AC power supply)



ASP3-K

Automatic WC flushing system, metal, 12 V (AC power supply)



ASP3-KT

Automatic WC flushing system, metal, manual, 12 V (AC power supply)

ASP3-B
Automatic WC flushing system, chrome, 6 V (DC battery operated)

ASP3-KB
Automatic WC flushing system, metal, 6 V (DC battery operated)

ASP3-KBT
Automatic WC flushing system, metal, manual, 6 V (DC battery operated)

The Sensor program includes products designed for non-contact use of toilet and urinal. The programme is designed for high usage installations and fully complies with the applicable EU hygiene standards. The sensors are equipped with an adjustable hygienic rinse where the toilet bowl rinses itself with water after a selected number of flushes or after the specified time since the last flush. The Sensor program can be used for both wall-hung WC bowls and urinals.

Automatic flushing systems for urinals



ASP4

Automatic flushing system for urinal, chrome, 12 V (AC power supply)



ASP4-K

Automatic flushing system for urinal, metal, 12 V (AC power supply)



ASP4-KT

Automatic flushing system for urinal, metal, manual, 12 V (AC power supply)

ASP4-B
Automatic flushing system for urinal, chrome, 6 V (DC battery operated)

ASP4-KB
Automatic flushing system for urinal, metal, 6 V (DC battery operated)



Sensor program benefits

 Simple setup, can be connected via mini USB to a computer or on a smart building management systems

 The program is available on the website www.alcaplast.com

 Possibility of setting hygienic rinse

 Magnetic switch for service setting and cleaning

 AC power supply or DC battery operated

 Selection of designs – chrome or metal

SPECIFICATION OF PRE-WALL INSTALLATION SYSTEMS ALCA

Flush plates compatibility

Flush plates ALCA:

They are fully compatible with all ALCA pre-wall installation systems.



Dual flush

Dual flush 3/6 l with a hygienic reserve:

The volume of water in the cistern: 9 l

Small flush: 3 l

Large flush: 6 l

Hygienic reserve: 3 l

After the large flush a three-liter-reserve remains for the possible need of additional rinsing.

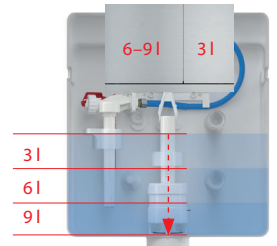

Ecological flushing

Any pre-wall installation system **ALCA** (except Slim system) can be easily converted to the **ECOLOGY** variant by replacing the standard flushing valve with the A06E valve and choosing the right type of WC ceramics. Flushing volume can be adjusted from 2 to 6 litres.



Water flow control

By inserting and setting of the water flow control you can change the dynamics of the water flow, thus avoiding unwanted splashing of water during flushing. The reduction is suitable for all types of pre-wall installation systems, flushing valves and cisterns **ALCA**. (except Slim system and A08A).

Water flow speed regulator can be ordered separately (P115).



1 piece cistern

Guaranteed impermeability:

The water cistern is made in one piece, which ensures its absolute impermeability.

100% control:

Tightness of each cistern is controlled by air pressure.

Quality material:

Polyethylene (PE) – ensures long-term stable characteristics and durability.



Template for correct flush plate setup

The new template will greatly assist in setting the flush mechanism to achieve the perfect functioning. It is included in the flush plate packaging.





Visit us on the Web



New feet lock system

The feet lock system allows **setting the necessary building height of the frame profile** and then you ensure its final position by tightening. This eliminates the need for the assistance of another person during the installation and also increases the accuracy of the installation.



Spare parts

25-year availability guarantee of all spare parts.

Spare parts catalogue:

Download on website www.alcaplast.com.

Consulting:

Possibility of telephone and internet consultations with Alcaplast engineers.



Safe and easy water connections

Closing the water inlet in the cistern:

Angle valve SCHELL (saddle).

Connection to the transition fitting:

Mounted during production, guaranteed tightness.

Water supply pipe with o-ring.

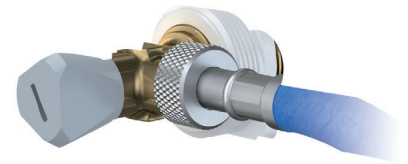

Optional accessories

All accessories included in packing:

The packaging of every product contains a complete set of installation accessories for mounting the WC bowl, including anchoring material and all necessary installation caps.



All with one wrench

The sizes of the bolt heads were unified for the pre-wall installation systems. **Newly, installation now requires only one wrench size** to install the whole pre-wall installation system.



Simple setup

All components that require to be fixed, adjusted or set up in the system have been **highlighted in red**. The aim is to simplify installation steps and thereby speed up the installation.

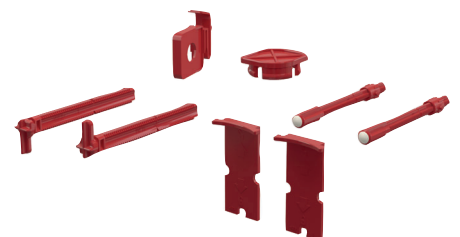



Visit us on the Web



Czech 100 Best Companies

For the third consecutive year Alcaplast defended its position among the hundred most successful Czech companies. In 2019 finished an excellent 36th place.



Company foundation

Czech family business which was founded in 1998. At that time, we produced only two products – fill and flushing valve. The current wide range of Alcaplast products has become the best selling in their field in many countries all over the world.



Czech product from Czech engineers

Quality, technical solutions, innovation, design – these are the primary characteristics of Alcaplast products. The high level of professionalism and skill of our Czech technicians is based on the historical tradition of Czech industry, which is over 100 years old, and renowned worldwide for its top quality products that are modern and extremely reliable.

ALCA – a premium brand

Premium brand ALCA represents a number of design products thoroughly elaborated with high utility value with Alcaplast being the creator of new trends in sanitary technology. Our cooperation with leading Czech designers in creating new product lines has won us several prestigious awards.



Leader in Europe

Ten years ago Alcaplast started the first production of stainless steel shower drains. Thanks to first-class manufacturing, material quality and flow rate of more than 60 liters per minute, we are the market leader in Europe. The customers appreciate the smart details, long life and high reliability.



Alcaplast Academy

The Alcaplast Academy was established in 2009. The training center was introduced to support education of Alcaplast customers based on the presentation and direct professional training associated with our products. Alcaplast Academy was ranked second in the category of training centers in "Business Project 2010". Over 3,000 professionals pass through our training every year. They are a guarantee of professional installation and technical support in the market.



EY Entrepreneur Of The Year in the Czech Republic

2018 Award Winner

EY Entrepreneur of the Year 2018

Succeeding in such a competitive environment is not easy. The founders of Alcaplast company won the competition, where more than 100 entrepreneurs competed for victory.

"We feel pride, humility and very much appreciate the award. We were in a great company among amazing and inspiring people. It is good that there is competition, which has the same criteria in all the countries, expands awareness of our business story and motivates future businessmen and businesswomen."

Radka Prokopová and František Fabičovic
husband and wife and Alcaplast company founders



Alcaplast International

Branches:

- Slovakia ■ Hungary ■ Poland ■ Romania
- Russia ■ Ukraine ■ Belarus ■ Georgia ■ Serbia

We design our products so that they can simplify life across many countries. They are universal and they meet demanding international standards. Alcaplast distribution warehouses and sales teams in countries outside of the Czech Republic provide flexible communication and service to our customers.

TRADITIONAL
QUALITY.
WITH ELEGANCE
AND INNOVATION.
SO WE APPROACH
OUR WORK. ■

PRE-WALL INSTALLATION SYSTEMS.

Alca PLAST®

CZECH REPUBLIC

Alca plast, s. r. o.
Bratislavská 2846, 690 02 Břeclav
tel.: +420 519 821 117 – Sales Dept CZ
tel.: +420 519 821 041 – Export Dept
fax: +420 519 821 083
e-mail: alcaplast@alcaplast.com
www.alcaplast.com

The Alcaplast team of specialists is always on hand to help with design, installation and quote project prices.

Czech product
ISO 9001:2015

Edition 1/2020 EN, © Alca plast, s. r. o.
Changes in dimensions and design reserved.



2014/30/EU, 2014/35/EU, 2011/65/EU,
2006/42/ES, 2011/305/EU, EN14055,
NV 117/2016, NV 118/2016, NV 481/2012,
NV 176/2008, ČSN EN14055

Legislative requirements vary according to product type